

LIFE SEW SAVORY

Kid Raglan T-Shirt Pattern

18mths-10Y

Full tutorial: <https://lifesewsavory.com/free-raglan-shirt-pattern-kids/>

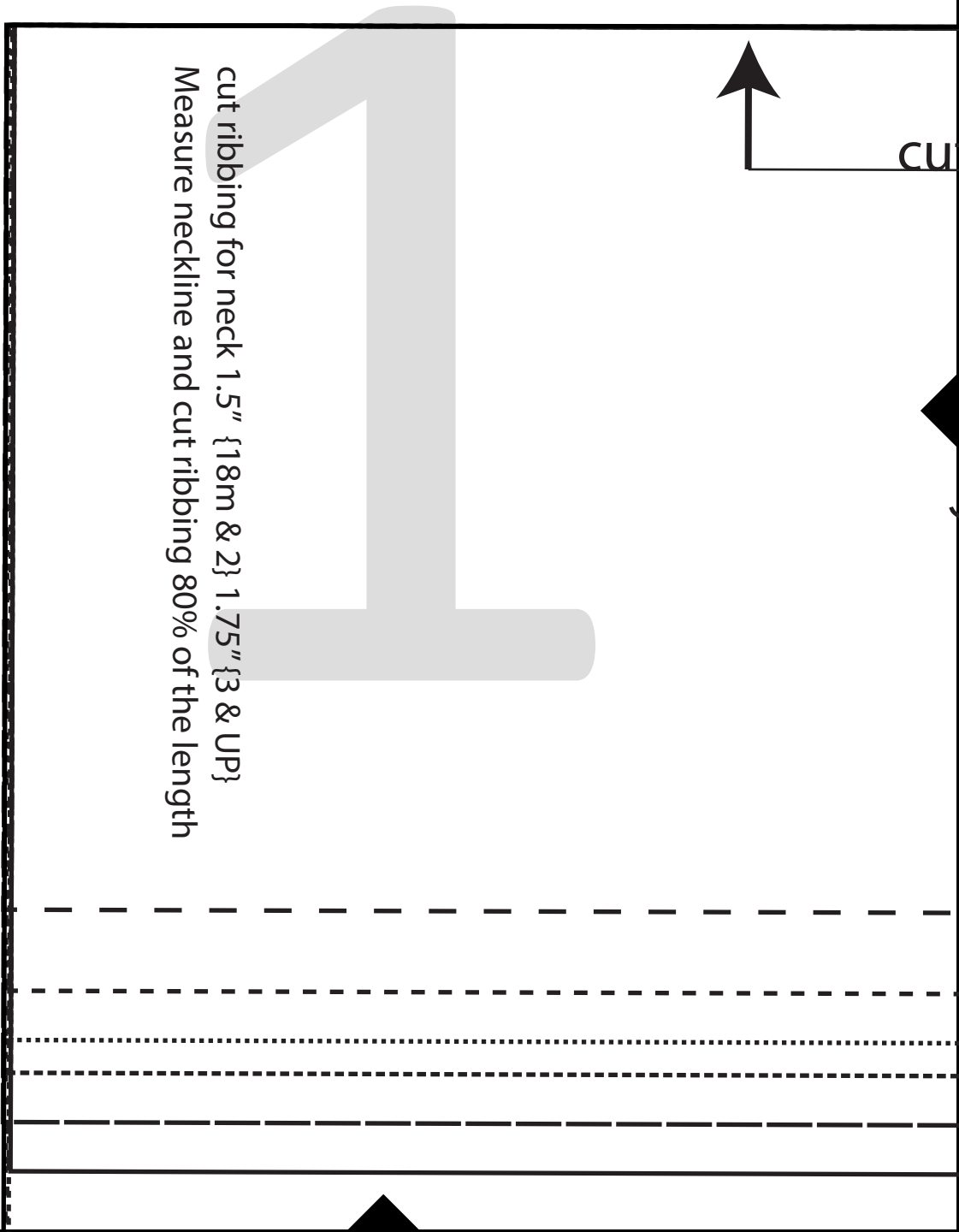

cut ribbing for neck 1.5" {18m & 2} 1.75" {3 & UP}
Measure neckline and cut ribbing 80% of the length

CUT



| Size | 18mths | 2T | 3 |
|---------------------------|--------|------|---|
| Chest | 49.5 | 50.5 | |
| Arm length | 26 | 29 | |
| All measurements in cm... | | | |

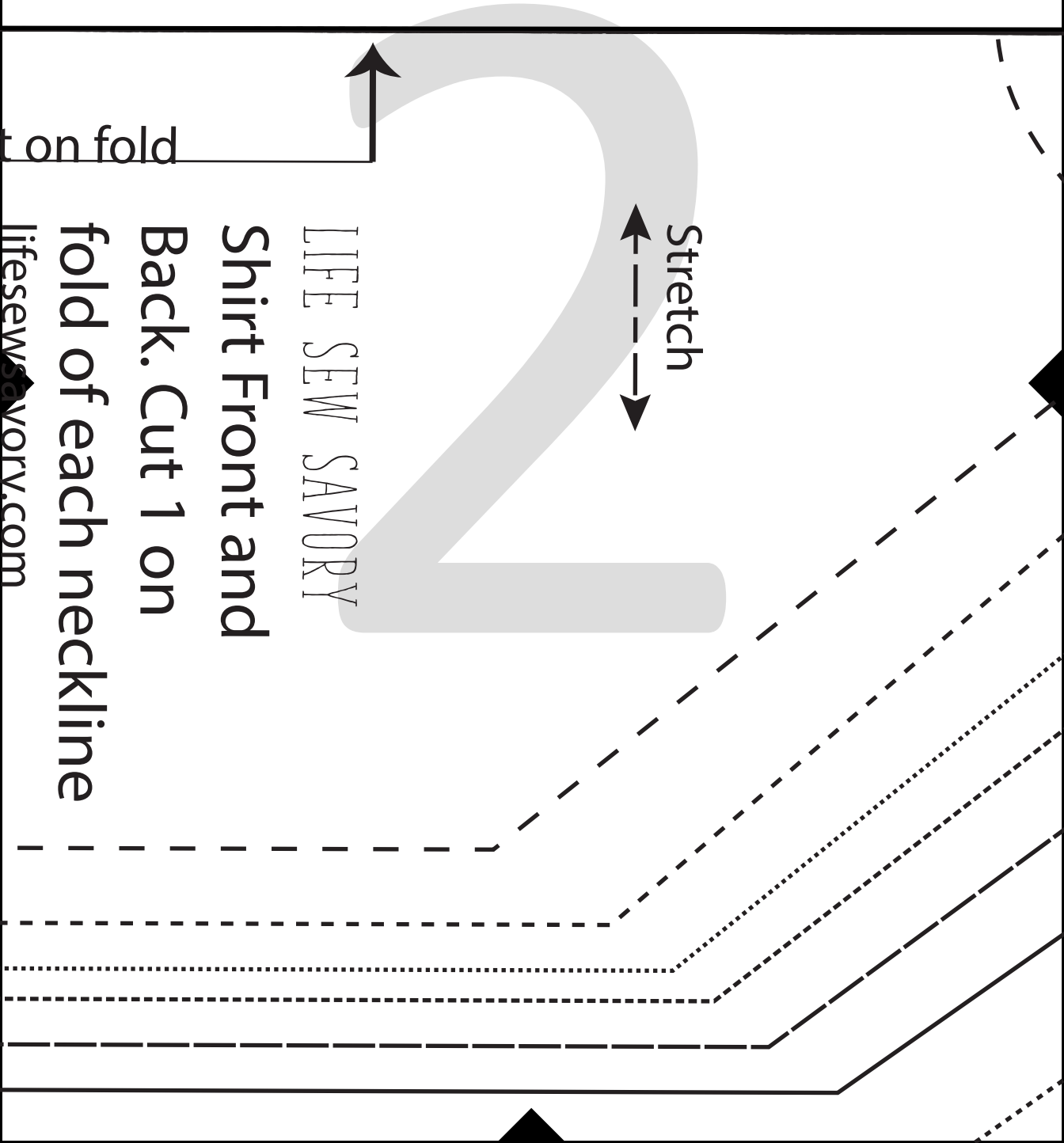

Cut on fold

LIFE SEW SAVORY

Shirt Front and

Back. Cut 1 on

fold of each neckline

lifesewsavory.com

Stretch

| 3T | 4T | 5T | 6T | 7Y | 8Y | 9Y | 10Y |
|------|----|------|----|----|----|----|-----|
| 53.5 | 56 | 58.5 | 61 | 66 | 68 | 70 | |
| 32 | 35 | 38 | 41 | 44 | 46 | 48 | |
| | | | | | | | |

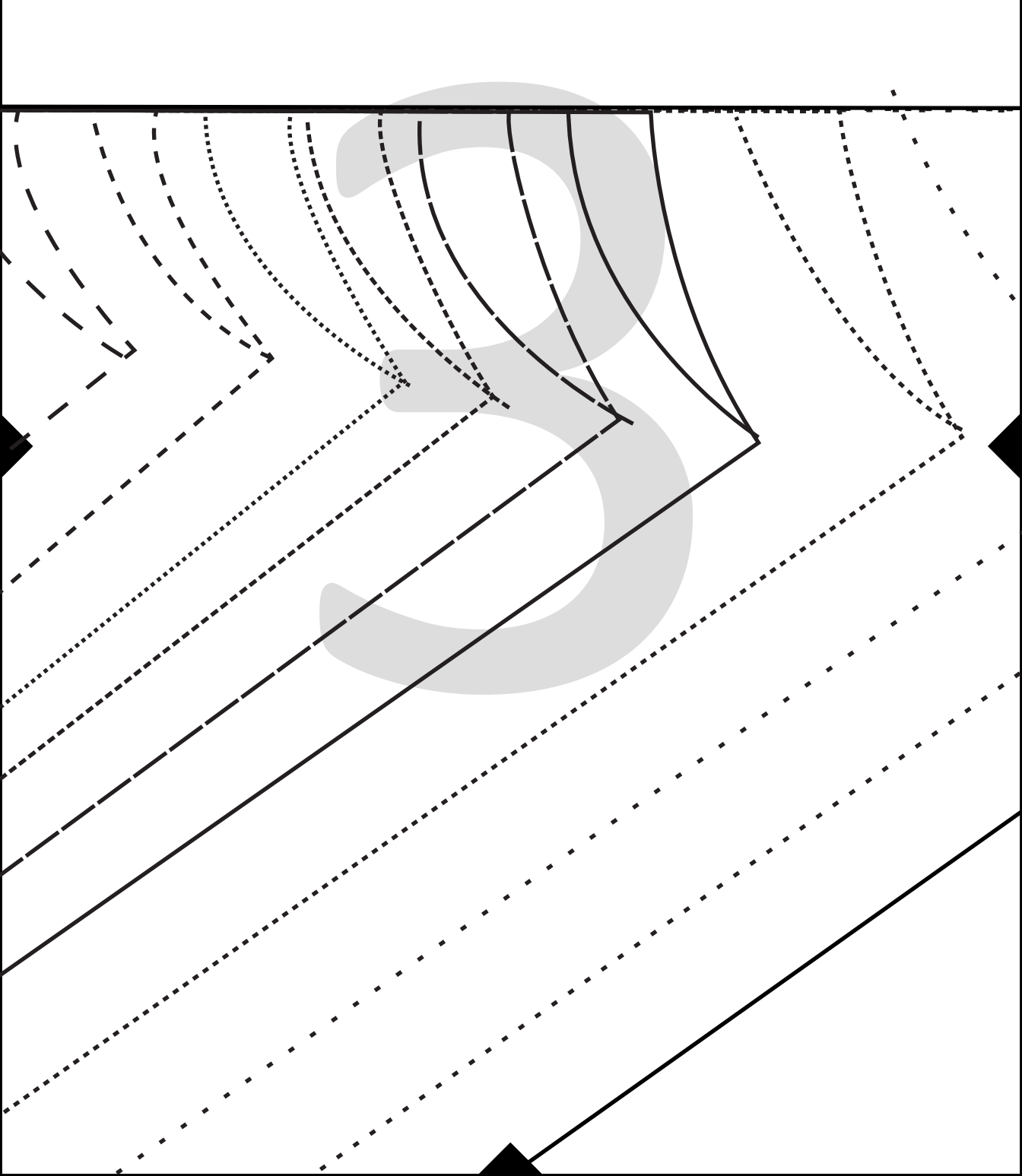

| |
|----|
| |
| 73 |
| 50 |
| |
| |

Key

18m - - - - -

2t - - - - -

3t

4t

5t - - - - -

6t _____

7y

8y

9y

10y _____

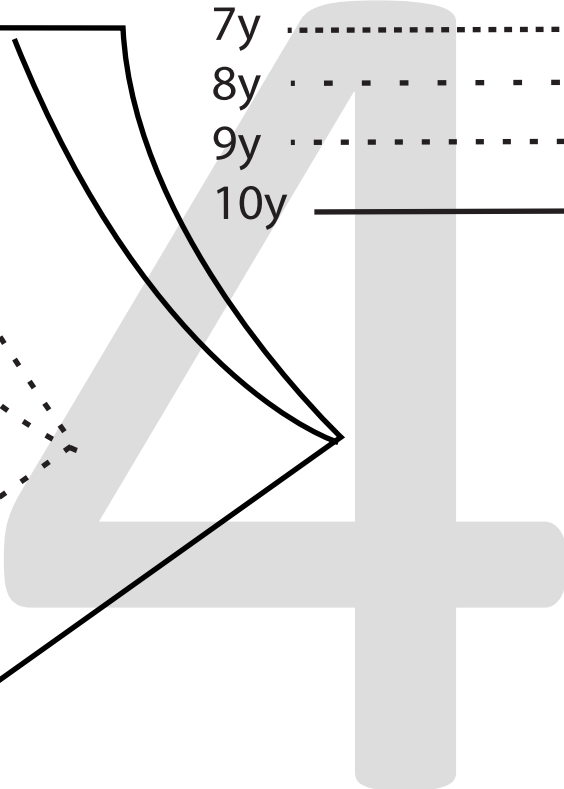
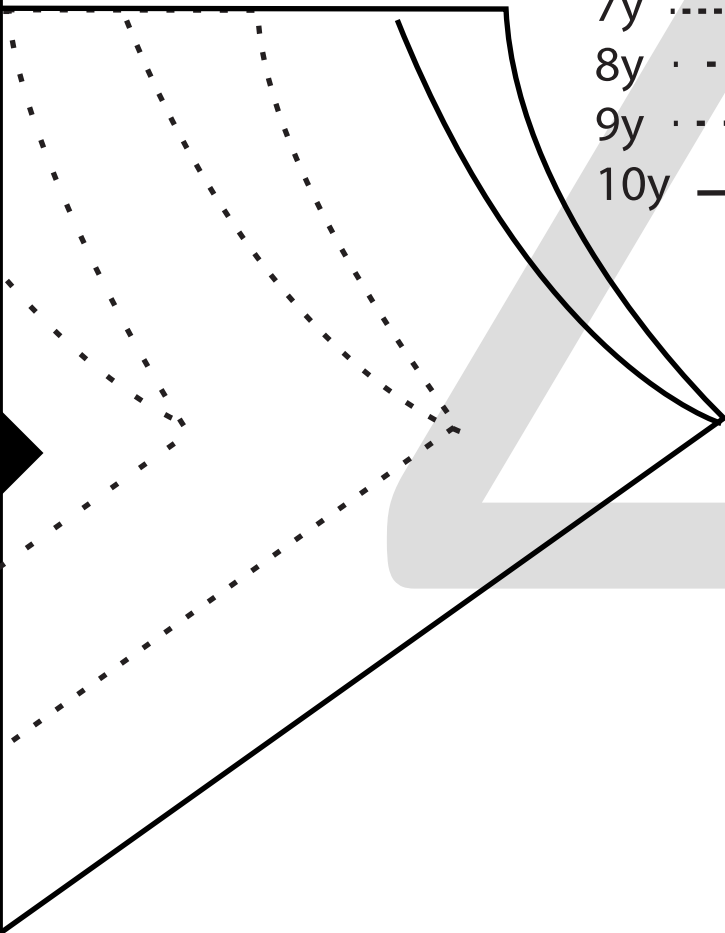

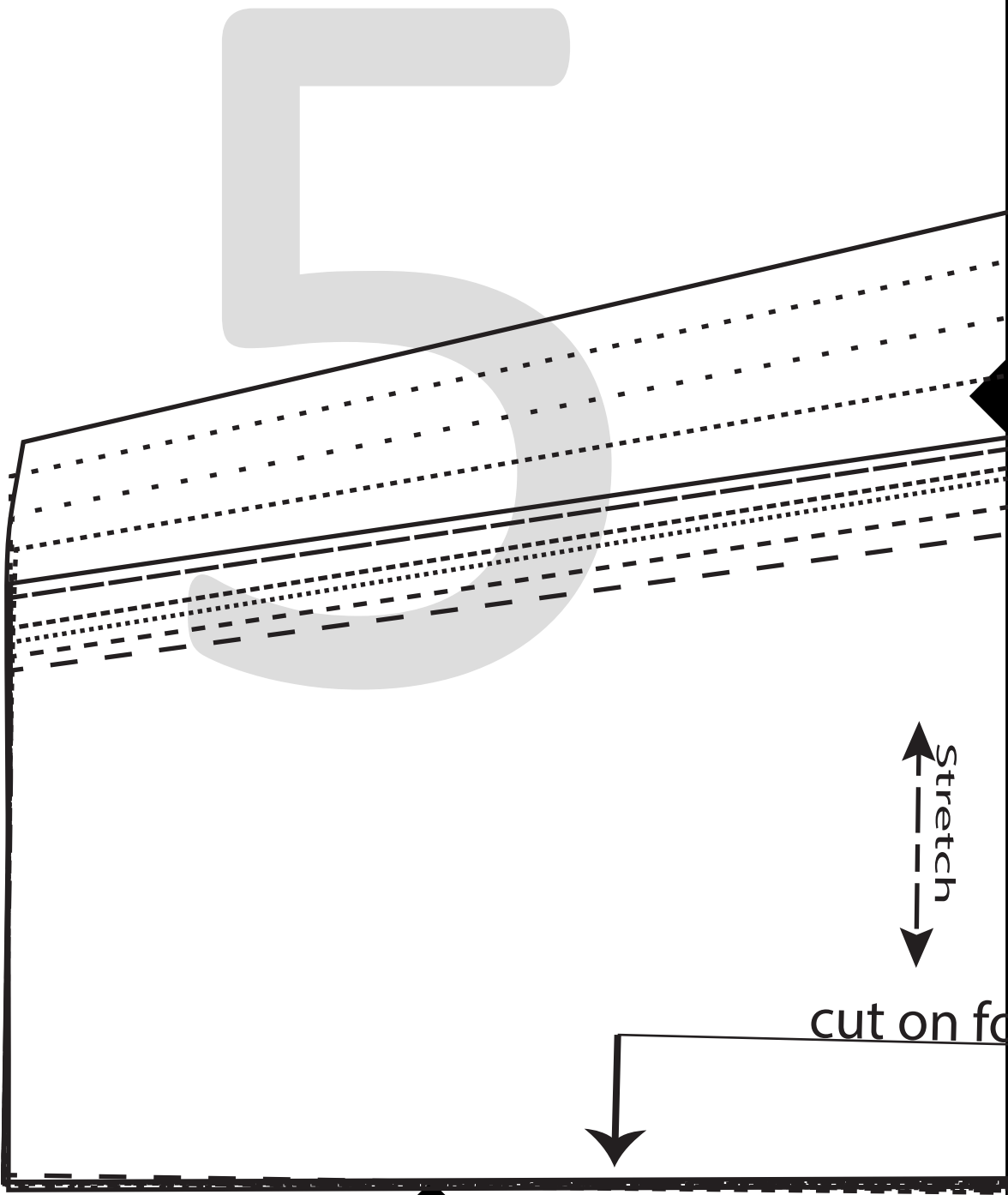
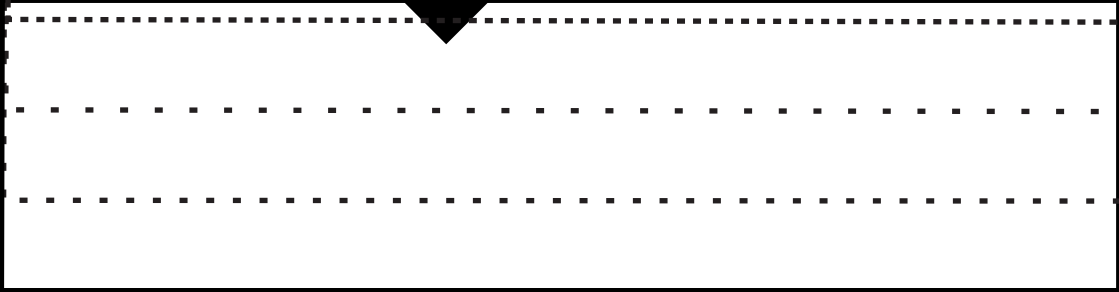

Stretch

cut on fo

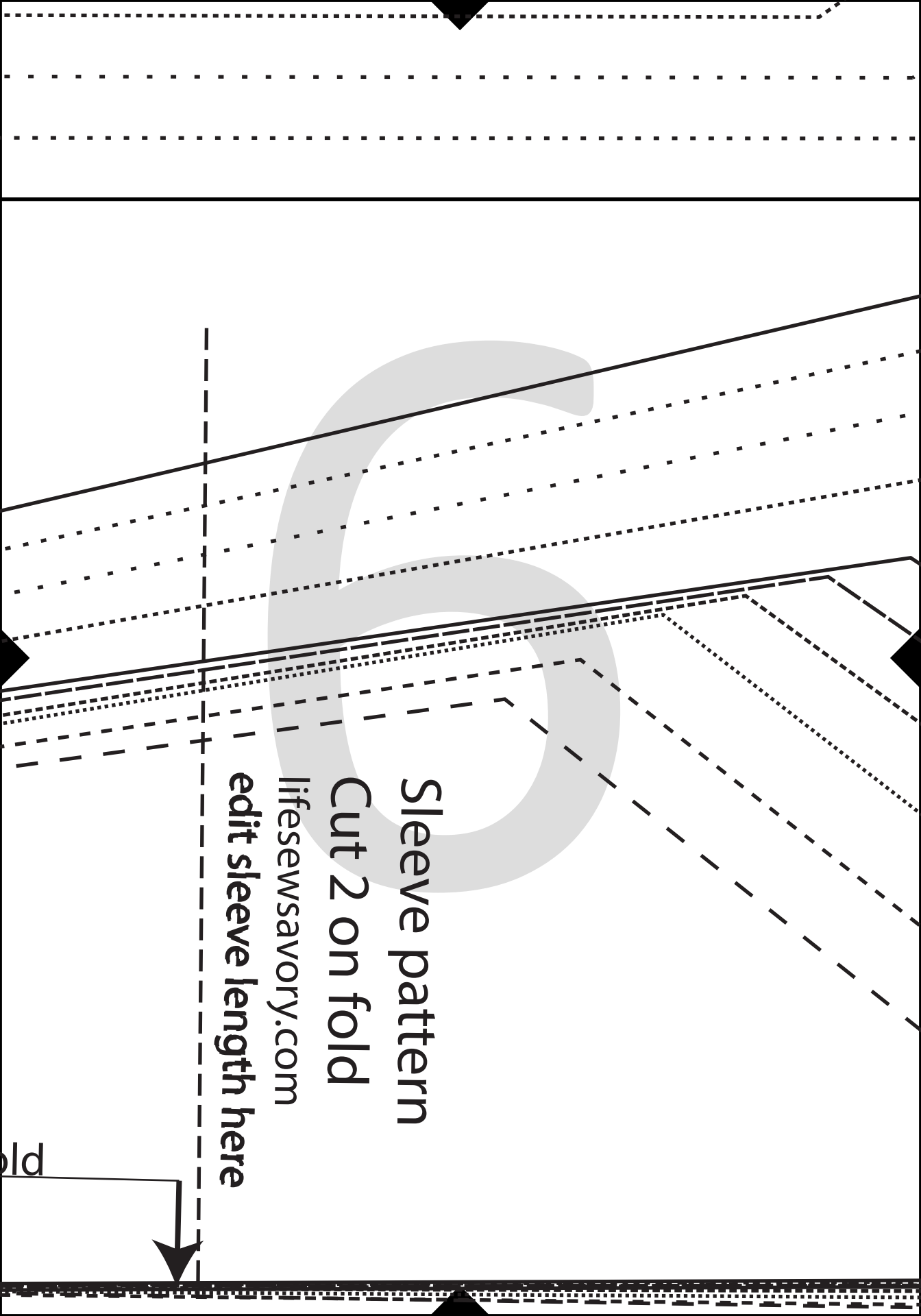

Sleeve pattern

Cut 2 on fold

lifesewsavory.com

edit sleeve length here

fold

